

Canal equipado

Canales equipados

Código: 3024 800



CARACTERÍSTICAS

FREGADEROS DE ESPESOR

Acero 1 mm de espesor. Un espesor importante que garantiza máxima robustez para los fregaderos que no conocen las señales del envejecimiento.

DETALLES

Borde Instalación

Enrasado | FTS

Material

Acero inoxidable AISI 304

Acabado

Foster cepillado

Texture

Cepillado en la línea

Base

45 cm

Dimensiones externas

450 x 170 mm

Dimensiones internas

422 x 142 mm

Anchura 45 cm

Longitud 3 unidad - Standard

Hueco de encastre Ver hoja de datos técnicos

Dotaciones estándar Soportes de fijación, junta, desagüe, caja de embalaje

Desagüe Desagüe 1¼"

Clave de lectura para los accesorios. Las longitudes de los canales y accesorios se indican en "unidades", para la composición la suma de las "unidades" de los accesorios debe corresponder a la longitud en "unidades" del canal.

DIBUJOS TÉCNICOS

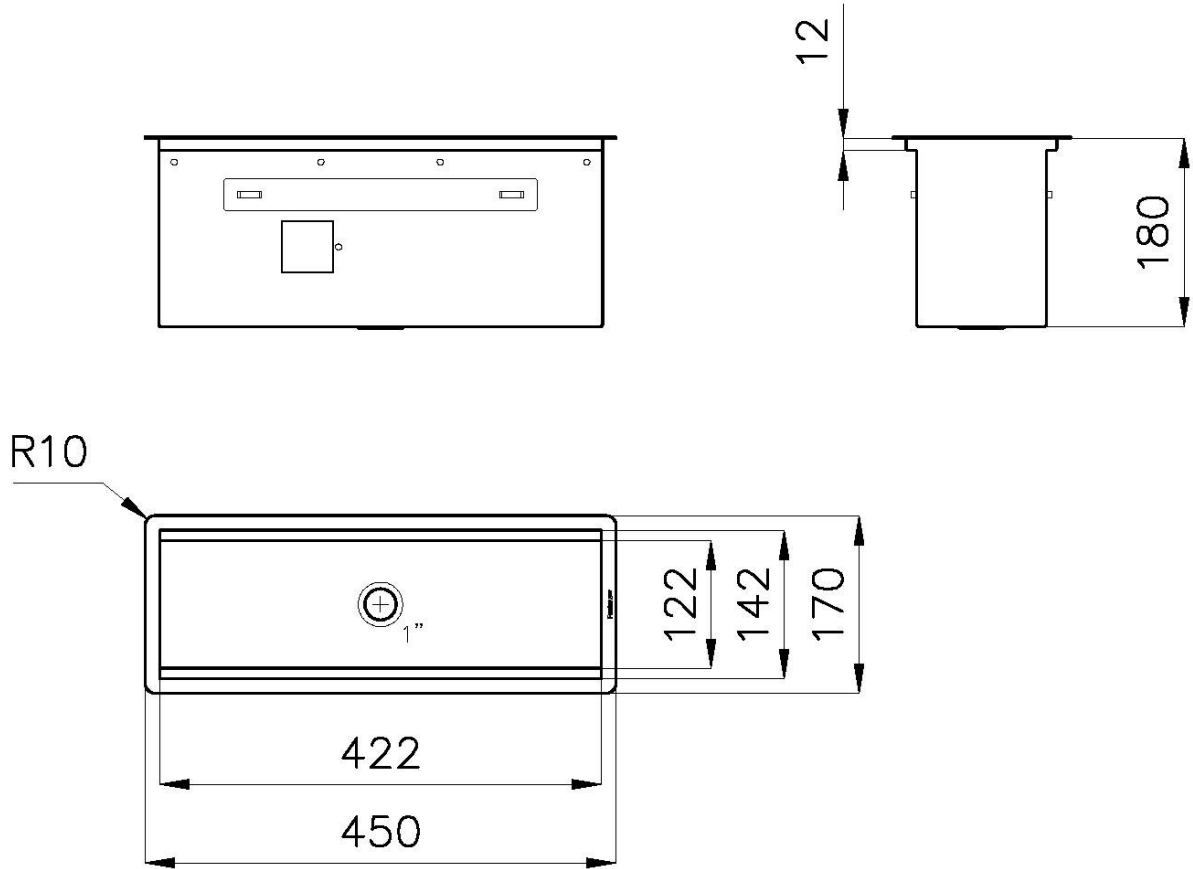

Filotop/Flush-mount

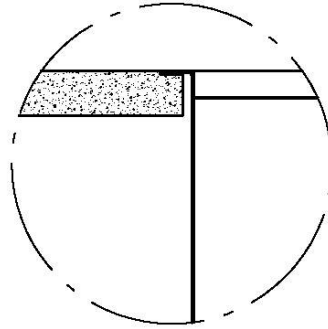

B-B:
Dettaglio installazione
Installation detail

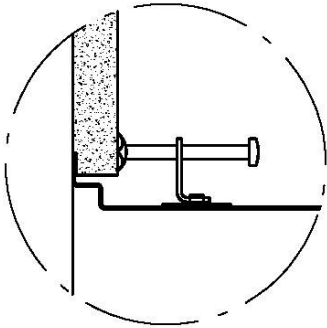

A-A:
Dettaglio installazione e sistema di fissaggio
Installation detail and fixing system

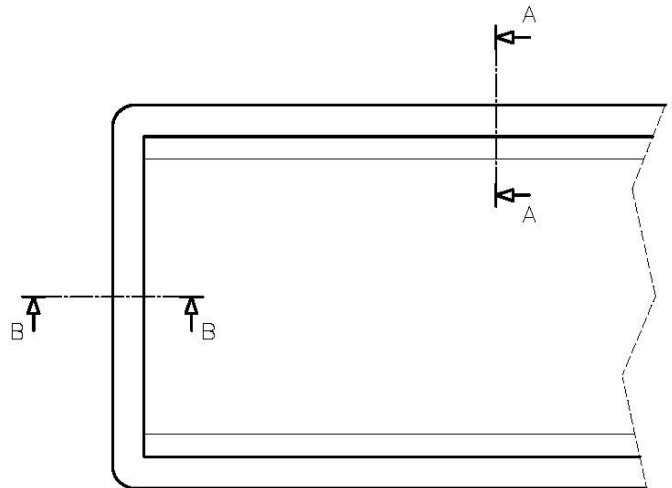

Dimensioni per foratura top
Cut out size

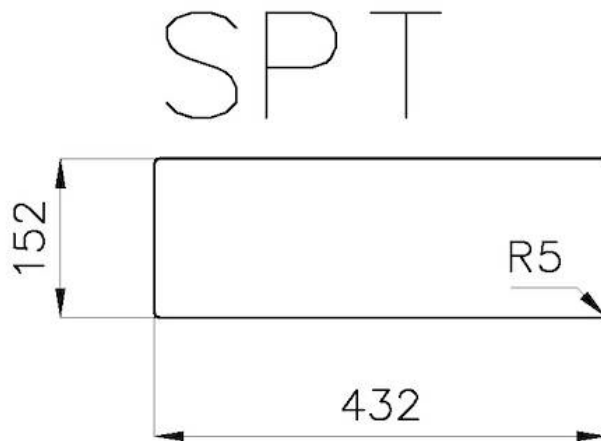
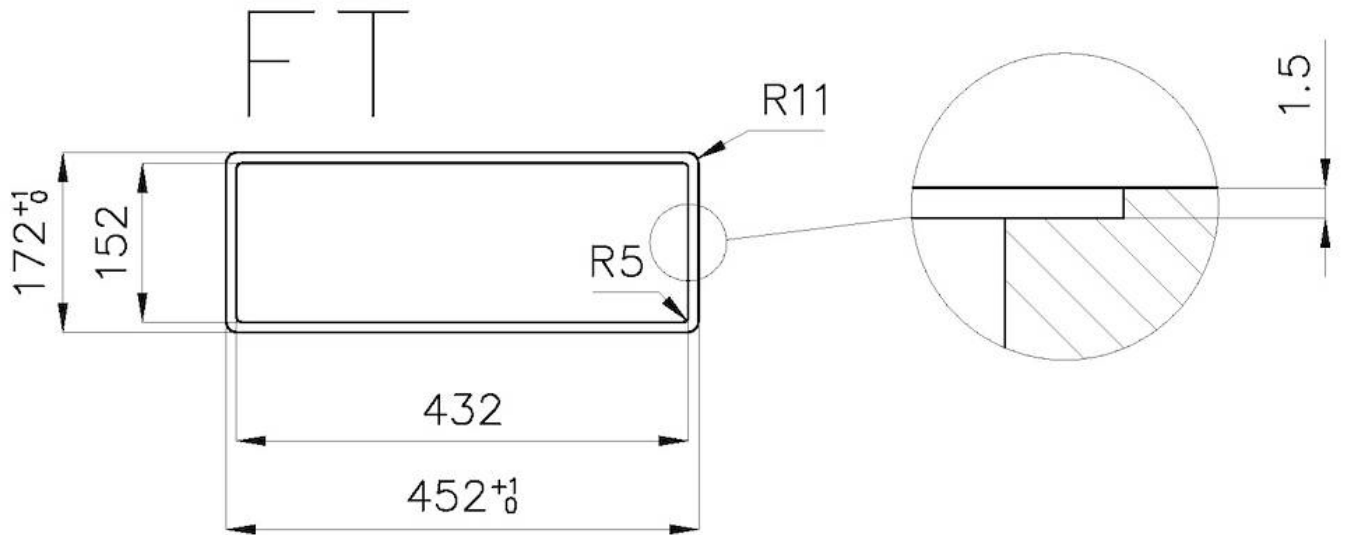

GALERÍA

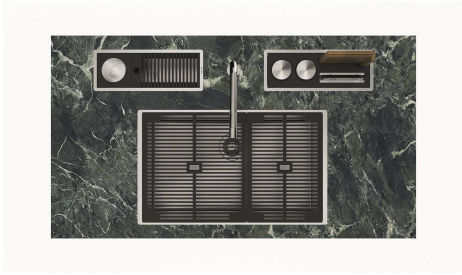

ACCESORIOS OPCIONALES



Bandeja perforada inox
8151 003



Kit "A"
8100 703



Kit "B"
8100 700



Kit "C"
8100 701



Kit "D"
8100 704



Kit "E"
8100 705



Kit "F"
8100 706



Kit "G"
8100 710



Kit "H"
8100 702



Kit "N"
8100 714



Portaplatos inox
1773 100



Stainless steel knife holder
8100 712



**Tomas múltiples de acero
inoxidable**
8000 020